

MediaPack™ Analog VoIP Gateways
Series

MP-11x Fast Track Installation Guide
MGCP, H.323 & SIP

Version 4.6

Document #: LTRT-61504



MP-11x

Fast Track Installation Guide

MGCP, H.323 & SIP

Version 4.6

Document #: LTRT-61504

Published July 2005



Notice

This Fast Track Installation Guide describes the installation of the AudioCodes MediaPack Series MP-11x VoIP gateways applying to MGCP, H.323 and SIP versions.

Information contained in this document is believed to be accurate and reliable at the time of printing. However, due to ongoing product improvements and revisions, AudioCodes cannot guarantee the accuracy of printed material after the Date Published nor can it accept responsibility for errors or omissions.

Updates to this document and other documents can be viewed by registered Technical Support customers at www.audiocodes.com under Support / Product Documentation.

© **Copyright 2005 AudioCodes Ltd. All rights reserved.**

This document is subject to change without notice.

Date Published: Jul-03-2005

Date Printed: Jul-27-2005

Table of Contents

1	Quick Start	7
2	Installing the MP-11x	8
2.1	Unpacking	8
2.2	Package Contents	8
2.3	19-inch Rack Installation Package	9
2.4	Mounting the MP-11x	9
2.4.1	Mounting the MP-11x on a Desktop	10
2.4.2	Mounting the MP-11x on a Wall	10
2.4.3	Installing the MP-11x in a 19-inch Rack	10
2.5	Cabling the MP-11x	11
2.5.1	Cables and Cabling Procedure	11
3	Configuring the MP-11x	13
3.1	Assigning the MP-11x IP Address	13
3.1.1	Assigning an IP Address Using HTTP	13
3.1.2	Assigning an IP Address Using BootP	14
3.1.3	Assigning an IP Address Using the CLI	15
3.1.3.1	Access the CLI	15
3.1.3.2	Assign an IP Address	16
3.2	Restoring Networking Parameters to their Initial State	16
3.3	Accessing the Embedded Web Server	17
3.4	Configuring the MP-11x <i>Basic Control Protocol</i> Parameters	17
3.4.1	Configuring Basic MGCP Parameters	18
3.4.2	Configuring Basic H.323 Parameters	19
3.4.3	Configuring Basic SIP Parameters	21
3.4.4	Example of Connecting Two MP-118 Devices	23
4	Changing the MP-11x Username and Password	24
5	Restoring and Backing Up the MP-11x Configuration	25
6	Monitoring the MP-11x	26
6.1	Monitoring the MP-11x Front Panel LEDs	26
6.2	Monitoring the MP-11x Channels	27
7	Upgrading the MP-11x	28
7.1	Software Upgrade Wizard	28
7.2	Updating the Auxiliary Files	33
8	Regulatory Information	35

List of Figures

Figure 1-1: Required Steps to Install the MP-11x	7
Figure 2-1: 19-inch Rack Shelf	9
Figure 2-2: View of the MP-11x Base	9
Figure 2-3: MP-11x Rack Mount	10
Figure 2-4: MP-118 Rear Panel Connectors	11
Figure 2-5: RJ-45 Ethernet Connector Pinout	12
Figure 2-6: RJ-11 Phone Connector Pinout	12
Figure 2-7: PS/2 Pinout	12
Figure 3-1: Client Configuration Screen with Blank Parameters	15
Figure 3-2: Embedded Web Server Login Screen	17
Figure 3-3: MP-11x MGCP Quick Setup Screen	18
Figure 3-4: MP-11x H.323 Quick Setup Screen	19
Figure 3-5: MP-11x SIP Quick Setup Screen	21
Figure 3-6: Example of Connecting Two MP-118 Devices	23
Figure 4-1: Change Password Screen in Administrator Mode	24
Figure 5-1: Configuration File Screen	25
Figure 6-1: MP-11x Channel Status Screen	27
Figure 7-1: Start Software Upgrade Screen	28
Figure 7-2: Load a <i>cmp</i> File Screen	29
Figure 7-3: <i>cmp</i> File Successfully Loaded into the Device Notification	29
Figure 7-4: Load an <i>ini</i> File Screen	30
Figure 7-5: Load a CPT File Screen	31
Figure 7-6: FINISH Screen	31
Figure 7-7: 'End Process' Screen	32
Figure 7-8: Auxiliary Files Screen	34

List of Tables

Table 2-1: View of the MP-11x Base	9
Table 2-2: MP-11x Rack Mount	10
Table 2-3: MP-11x Rear Panel Component Descriptions	11
Table 2-4: Cables and Cabling Procedure	11
Table 3-1: MP-11x Default Networking Parameters	13
Table 6-1: Definition of MP-11x Front Panel LED Indicators	26
Table 6-2: Channel Status Color Indicators	27
Table 7-1: <i>ini</i> and Auxiliary Files Descriptions	33



Tip: When viewing this manual on CD, Web site or on any other electronic copy, all cross-references are hyperlinked. Click on the page or section numbers (shown in blue) to reach the individual cross-referenced item directly. To return back to the point from where you accessed the cross-reference, press the **ALT** and **◀** keys.

Trademarks

AC logo, Ardito, AudioCoded, AudioCodes, AudioCodes logo, IPmedia, Mediant, MediaPack, MP-MLQ, NetCoder, Stretto, TrunkPack, VoicePacketizer and VoIPerfect, are trademarks or registered trademarks of AudioCodes Limited. All other products or trademarks are property of their respective owners.

Customer Support

Customer technical support and service are provided by AudioCodes' Distributors, Partners, and Resellers from whom the product was purchased. For Customer support for products purchased directly from AudioCodes, contact support@audiocodes.com.

Abbreviations and Terminology

Each abbreviation, unless widely used, is spelled out in full when first used. Only industry-standard terms are used throughout this manual. Hexadecimal notation is indicated by 0x preceding the number.

Related Documentation

Document #	Manual Name
LTRT-613xx (e.g., LTRT-61301)	MP-11x MGCP User's Manual
LTRT-616xx	MP Series Release Notes
LTRT-651xx	MediaPack H.323 User's Manual
LTRT-652xx	MediaPack H.323 Analog Gateways Release Notes
LTRT-654xx	MediaPack SIP User's Manual
LTRT-656xx	MediaPack & Mediant 1000 SIP Analog Gateways Release Notes



Note: The MP-112 differs from the MP-114 and MP-118. Its configuration excludes the RS-232 connector, the Lifeline option and outdoor protection.



Note: MP-11x refers to the MP-118 8-port, MP-114 4-port and MP-112 2-port VoIP gateways having similar functionality except for the number of channels.



Note: Where "network" appears in this manual, it means LAN, WAN, etc. accessed via the gateway's Ethernet interface.



Note: **FXS** (**F**oreign **E**xchange **S**tation) is the interface replacing the Exchange (i.e., the CO or the PBX) and connects to analog telephones, dial-up modems, and fax machines. The FXS is designed to **supply** line voltage and ringing current to these telephone devices. An FXS VoIP gateway interfaces between the analog telephone devices and the Internet.



Warning: Ensure that you connect FXS ports to analog telephone or to PBX-trunk lines only.



Warning: The MP-11x is supplied as a sealed unit and must only be serviced by qualified service personnel.

1 Quick Start

This guide provides you with information on how to install the MP-11x for the first time. Prior knowledge of IP networks is preferred.

Refer to the configuration procedures, outlined in [Figure 1-1](#), for information on how to install, initialize, configure the device and make calls. For detailed information on how to *fully* configure the gateway refer to the MP-11x User's Manuals.

Figure 1-1: Required Steps to Install the MP-11x

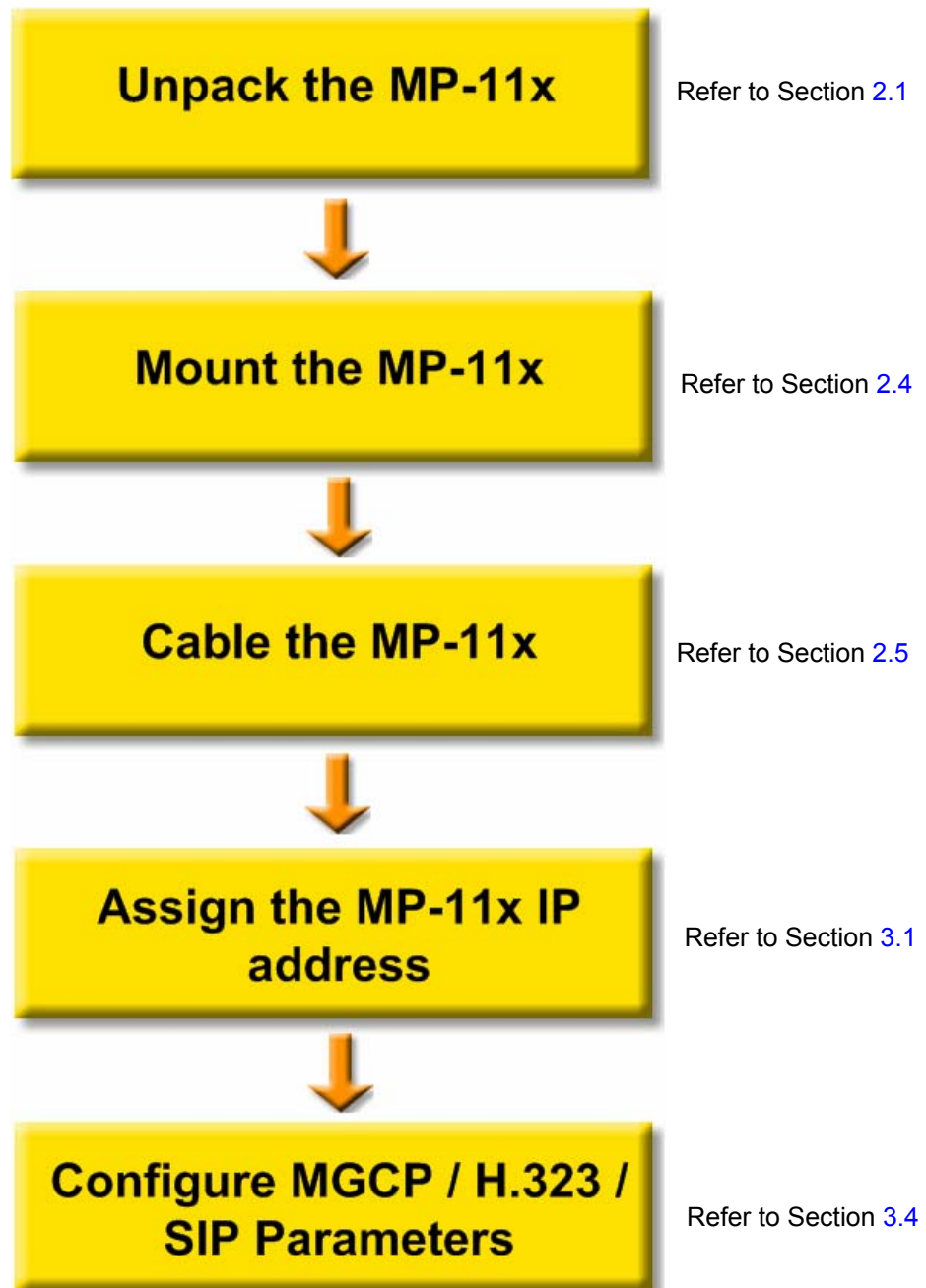

2 Installing the MP-11x



Caution Electrical Shock

The equipment must only be installed or serviced by qualified service personnel.

➤ **To install the MP-11x, take these 3 steps:**

1. Unpack the MP-11x (refer to Section 2.1 below).
2. Check the package contents (refer to Section 2.2 below).
3. Mount the MP-11x (refer to Section 2.4 on page 9).
4. Cable the MP-11x (refer to Section 2.5 on page 10).

After connecting the MP-11x to the power source, the Ready and Power LEDs on the front panel turn to green (after a self-testing period of about 2 minutes). Any malfunction in the startup procedure changes the Fail LED to red and the Ready LED is turned off (refer to Section 6.1 on page 26 for details on the MP-11x LEDs).

When you have completed the above relevant sections you are then ready to start configuring the gateway (Section 3 on page 13).

2.1 Unpacking

➤ **To unpack the MP-11x, take these 6 steps:**

1. Open the carton and remove the packing materials.
2. Remove the MP-11x gateway from the carton.
3. Check that there is no equipment damage.
4. Check, retain and process any documents.
5. Notify AudioCodes or your local supplier of any damage or discrepancies.
6. Retain any diskettes or CDs.

2.2 Package Contents

Ensure that in addition to the MP-11x, the package contains:

- AC power cable.
- Small plastic bag containing four anti-slide bumpers for desktop installation.
- A CD with software and documentation may be included.
- This Fast Track Installation Guide.

2.3 19-inch Rack Installation Package

Additional option is available for installing the MP-11x in a 19-inch rack. The 19-inch rack installation package contains a single shelf (shown in [Figure 2-2](#) below) and eight shelf-to-device screws.

Figure 2-1: 19-inch Rack Shelf

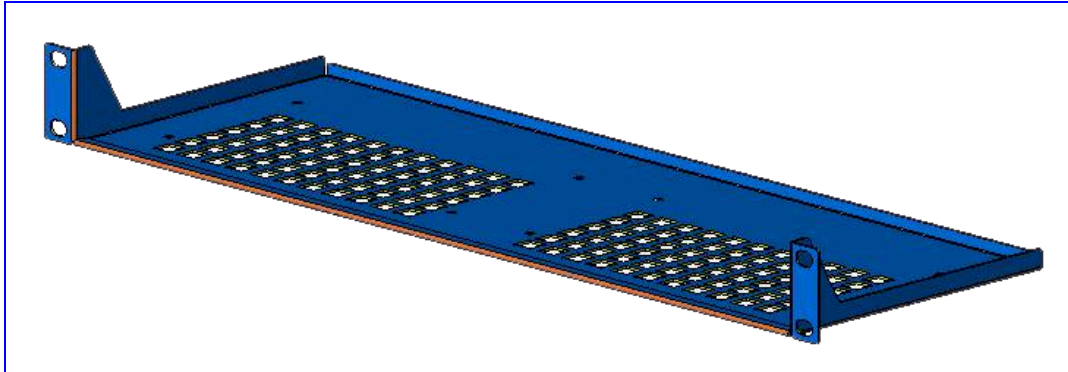

2.4 Mounting the MP-11x

The MP-11x can be mounted on a desktop (refer to [Section 2.4.1](#) below), on a wall (refer to [Section 2.4.2](#)) or installed in a standard 19-inch rack (refer to [Section 2.4.3](#)).

[Figure 2-2](#) below describes the design of the MP-11x base.

Figure 2-2: View of the MP-11x Base

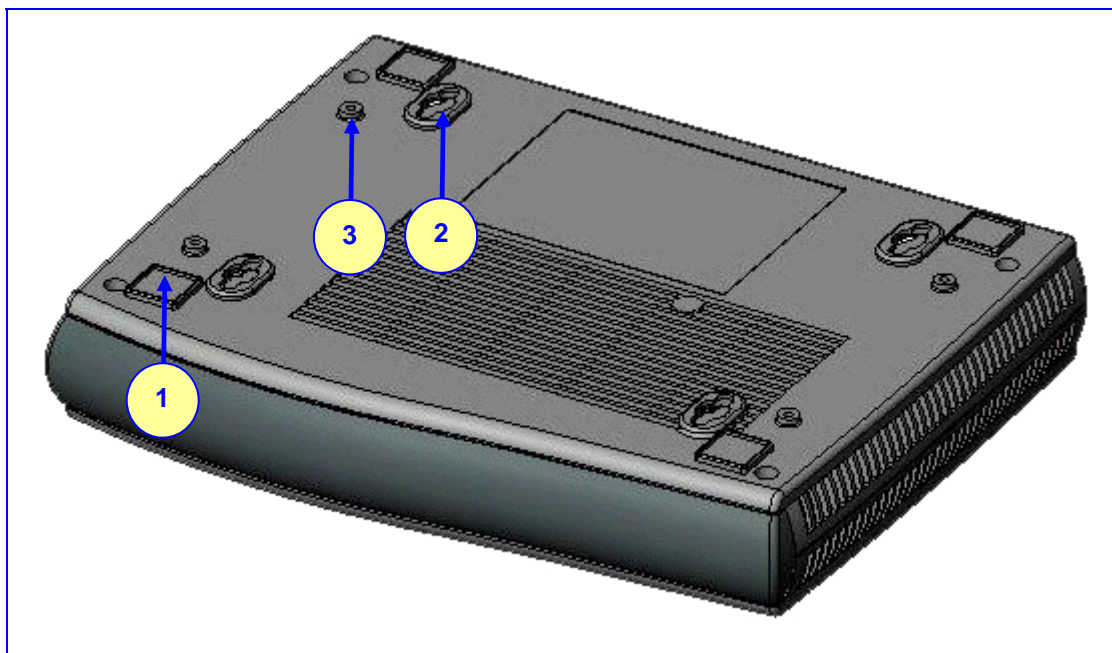

Table 2-1: View of the MP-11x Base

Item #	Functionality
1	Square slot used to attach anti-slide bumpers (for desktop mounting)
2	Oval notch used to attach the MP-11x to a wall
3	Screw opening used to attach the MP-11x to a 19-inch shelf rack

2.4.1 Mounting the MP-11x on a Desktop

Attach the four (supplied) anti-slide bumpers to the base of the MP-11x (refer to item #1 in [Figure 2-2](#)) and place it on the desktop in the position you require.

2.4.2 Mounting the MP-11x on a Wall

➤ **To mount the MP-11x on a wall, take these 4 steps:**

1. Drill four holes according to the following dimensions:
 - Side-to-side distance 140 mm.
 - Front-to-back distance 101.4 mm.
2. Insert a wall anchor of the appropriate size into each hole.
3. Fasten a DIN 96 3.5X20 wood screw (not supplied) into each of the wall anchors.
4. Position the four oval notches located on the base of the MP-11x (refer to item #2 in [Figure 2-2](#)) over the four screws and hang the MP-11x on them.

2.4.3 Installing the MP-11x in a 19-inch Rack

The MP-11x is installed in a standard 19-inch rack by placing it on a shelf preinstalled in the rack. This shelf can be ordered separately from AudioCodes.

Figure 2-3: MP-11x Rack Mount

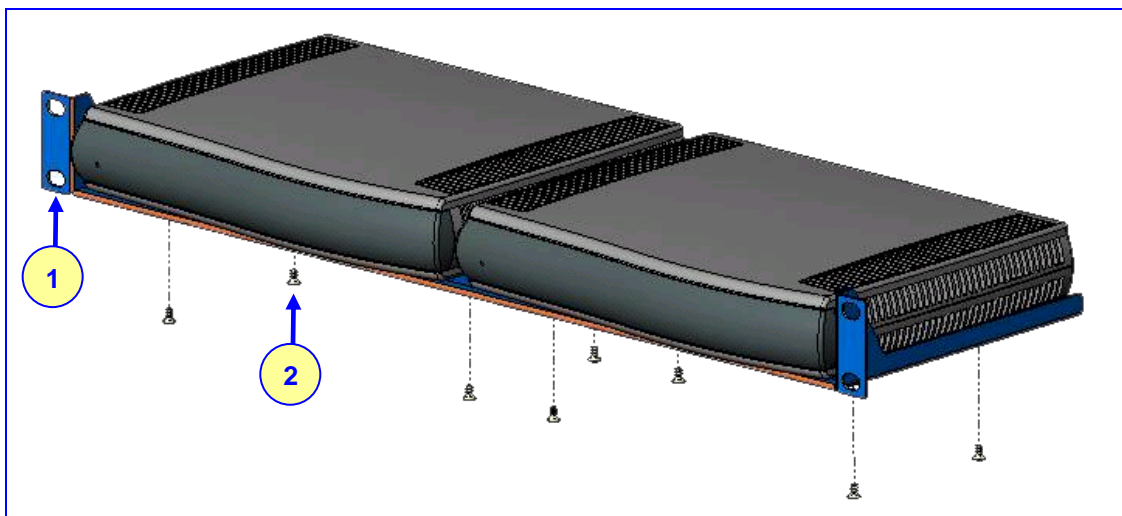

Table 2-2: MP-11x Rack Mount

Item #	Functionality
1	Standard rack holes used to attach the shelf to the rack
2	Eight shelf-to-device screws

➤ **To install the MP-11x in a 19-inch rack, take these 3 steps:**

1. Use the shelf-to-device screws found in the package to attach one or two MP-11x devices to the shelf.
2. Position the shelf in the rack and line up its side holes with the rack frame holes.
3. Use four standard rack screws to attach the shelf to the rack. These screws are not provided.

2.5 Cabling the MP-11x

Refer to [Table 2-4](#) below for the cabling procedure for the MP-11x.

Figure 2-4: MP-118 Rear Panel Connectors

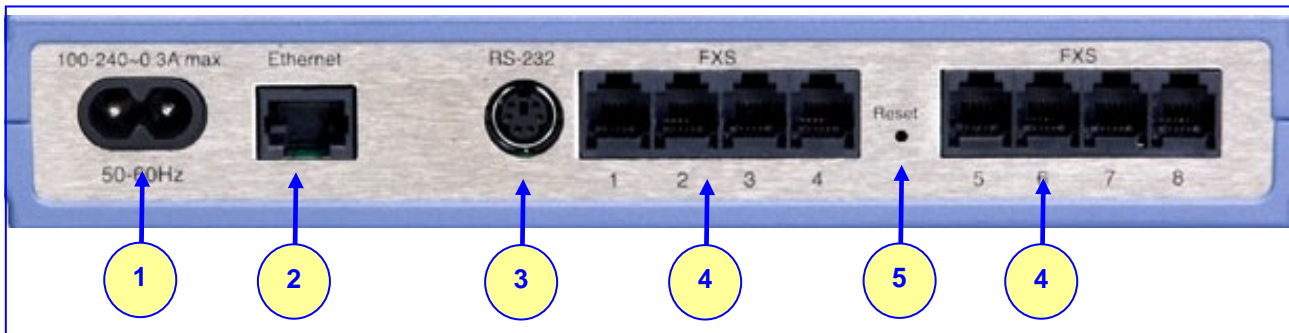

Table 2-3: MP-11x Rear Panel Component Descriptions

Item #	Label	Component Description
1	100-240~0.3A max.	AC power supply socket
2	Ethernet	10/100 Base-TX Uplink port
3	RS-232	RS-232 status port (requires a DB-9 to PS/2 adaptor)
4	FXS	4 RJ-11 FXS ports (total 8)
5	Reset	Reset button

2.5.1 Cables and Cabling Procedure

Verify that you have the cables listed under column 'Cable' in [Table 2-4](#) before beginning to cable the MP-11x according to the column 'Cabling Procedure'.

Table 2-4: Cables and Cabling Procedure

Cable	Cabling Procedure	
RJ-45 Ethernet cable	Connect the Ethernet connection on the MP-11x directly to the network using a standard RJ-45 Ethernet cable. For connector's pinout refer to Figure 2-5 on page 12. Note that when assigning an IP address to the MP-11x using HTTP (under step 1 in Section 3.1.1), you may be required to disconnect this cable and re-cable it differently.	
RJ-11 two-wire telephone cords	Connect the RJ-11 connectors on the rear panel of the MP-11x to fax machine, modem, or phones (refer to Figure 2-6).	Ensure that the FXS ports are connected to the correct devices, otherwise damage can occur.
RS-232 serial cable	Insert the RS-232 straight serial cable into the RS-232 port using the DB-9 to PS/2 adaptor (not supplied). Connect the standard DB9 RS-232 connector on the other end to a Terminal port. The pinout of the PS/2 connector is shown in Figure 2-7 . The RS-232 port is mainly used internally by service personnel for monitoring purposes. Advanced users can also use this feature to obtain log information (for example).	
AC Power cable	Connect the MP-11x power socket to the mains.	

Figure 2-5: RJ-45 Ethernet Connector Pinout

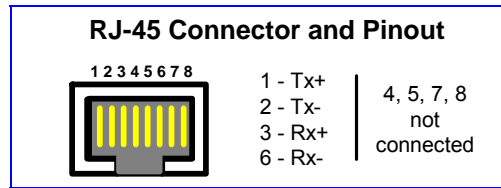

Figure 2-6: RJ-11 Phone Connector Pinout

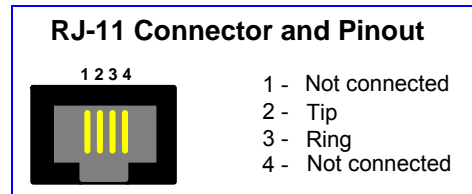
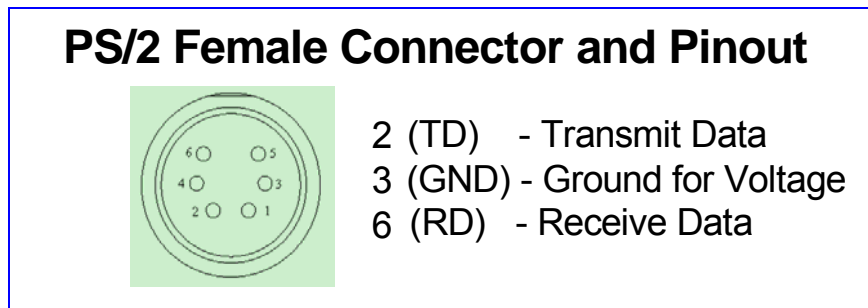

Figure 2-7: PS/2 Pinout



3 Configuring the MP-11x

The MP-11x application software already resides in the device's flash memory when it is supplied (with factory default parameters). MP-11x devices also include an Embedded (integrally stored) Web Server.

Section 3.1 below describes how to assign an IP address to the MP-11x, while Section 3.4 on page 17 describes how to set up the MP-11x with basic parameters using a standard Web browser (such as Microsoft™ Internet Explorer).



Note: Section 3.1 applies equally to MGCP, H.323 and SIP.

3.1 Assigning the MP-11x IP Address

To assign an IP address to the MP-11x use one of the following methods:

- HTTP using a Web browser (refer to Section 3.1.1 below).
- BootP (refer to Section 3.1.2 on page 14).
- DHCP (refer to the product's User's Manual).
- The embedded Command Line Interface (CLI) accessed via Telnet or RS-232 (refer to Step 3.1.3 on page 15).

The default networking parameters are show in Table 3-1.

Use the 'Reset' button at any time to restore the MP-11x networking parameters to their factory default values (refer to Section 3.2 on page 16).

Table 3-1: MP-11x Default Networking Parameters

Parameter	Default Value
IP Address	10.1.10.10
Subnet Mask	255.255.0.0
Default Gateway IP Address	0.0.0.0

3.1.1 Assigning an IP Address Using HTTP

➤ **To assign an IP address using HTTP, take these 8 steps:**

1. Disconnect the MP-11x from the network and reconnect it to your PC using one of the following two methods:
 - Use a standard Ethernet cable to connect the network interface on your PC to a port on a network hub / switch. Use a second standard Ethernet cable to connect the MP-11x to another port on the same network hub / switch.
 - Use a standard Ethernet cable to directly connect the network interface on your PC to the MP-11x.
2. Change your PC's IP address and subnet mask to correspond with the MP-11x factory default IP address and subnet mask, shown in Table 3-1. For details on changing the IP address and subnet mask of your PC, refer to Windows™ Online Help (Start>Help).
3. Access the MP-11x Embedded Web Server (refer to Section 3.3 on page 17).
4. In the 'Quick Setup' screen, set the MP-11x 'IP Address', 'Subnet Mask' and 'Default Gateway IP Address' fields under 'IP Configuration' *to correspond with your network IP*

settings. If your network doesn't feature a default gateway, enter a dummy value in the 'Default Gateway IP Address' field.

- Click the **Reset** button and click **OK** in the prompt; the MP-11x applies the changes and restarts. This takes approximately 2 minutes to complete. When the MP-11x has finished restarting, the Power and Ready LEDs on the front panel are lit green.



Tip: Record & retain the IP address and subnet mask you assign the MP-11x. Do the same when defining new username or password. If the Embedded Web Server is unavailable (for example, if you've lost your username and password), use the BootP/TFTP configuration utility to access the device, "reflash" the load and reset the password (refer to the MP-11x User's Manuals for detailed information on using a BootP/TFTP server to access the device).

- Disconnect your PC from the MP-11x or from the hub / switch (depending on the connection method you used in step 1).
- Reconnect the MP-11x and your PC (if necessary) to the network.
- Restore your PC's IP address & subnet mask to what they originally were. If necessary, restart your PC and re-access the MP-11x via the Embedded Web Server with its new assigned IP address.



3.1.2 Assigning an IP Address Using BootP



Tip 1: BootP procedure can also be performed using any standard compatible BootP server.

Tip 2: You can also use BootP to load the auxiliary files to the MP-11x (refer to the product's User's Manual).

➤ To assign an IP address using BootP, take these 12 steps:

- Open the BootP application (supplied with the software package).
- Click on the **Edit Clients** icon; the 'Client Configuration' screen is displayed. 
- Click on the **Add New Client** icon; a client with blank parameters is displayed (Figure 3-1). 
- In the 'Client MAC' field, enter the MAC address of the gateway. The MAC address is printed on a label located on the base of the MP-11x.
- Verify that the box to the right of the 'Client MAC' field is checked. This enables the particular client in the BootP tool (if the client is disabled, no replies are sent to BootP requests).
- In the 'Client Name' field, enter a descriptive name for this client so that it is easier to remember which gateway the record refers to. For example, this name could refer to the location of the gateway.
- In the 'IP' field, enter the IP address you want to apply to the gateway. Use the normal dotted decimal format.
- In the 'Subnet' field, enter the subnet mask you want to apply to the gateway. Use the normal dotted decimal format. Ensure that the subnet mask is correct. If the address is incorrect, the gateway may not function until the entry is corrected and a BootP reset is applied.
- In the 'Gateway' field, enter the IP address for the default gateway. If you do not know the IP address for the default gateway, contact your network administrator.
- Click **Apply** to save this entry to the list of clients.

11. Click **OK**; the 'Client Configuration' screen is closed.
12. Use the reset button (located on the MP-11x rear panel) to *physically* reset the gateway causing it to use BootP; the device changes its network parameters to the values provided by the BootP.

Figure 3-1: Client Configuration Screen with Blank Parameters

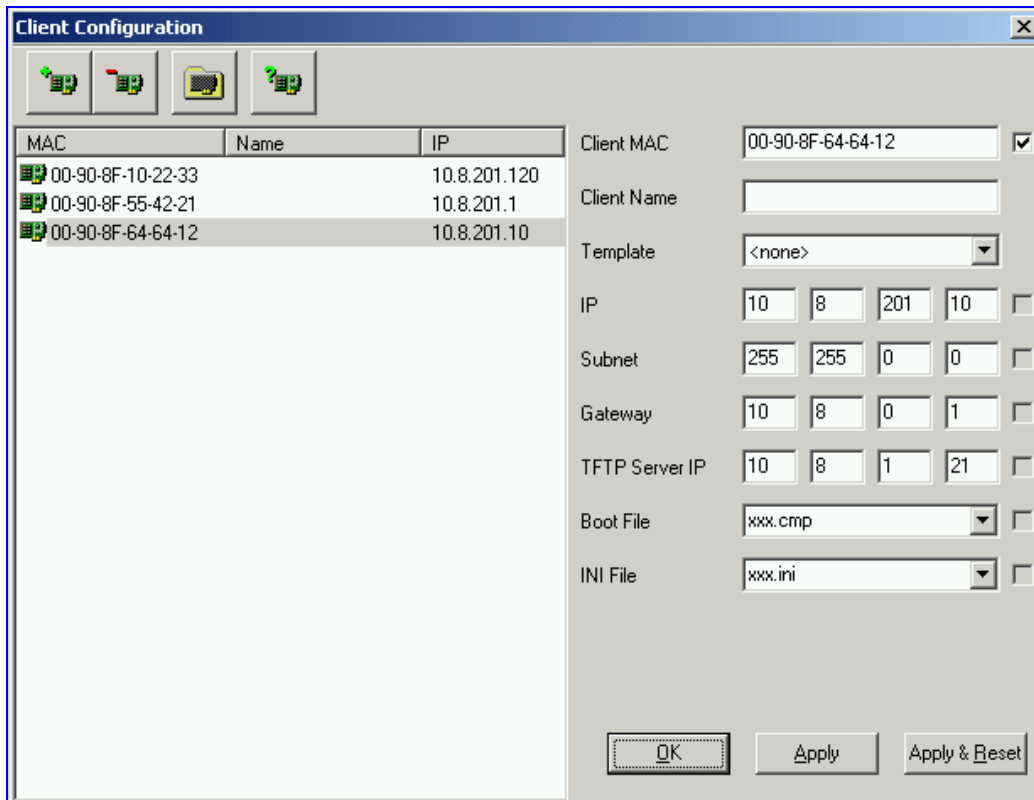

3.1.3 Assigning an IP Address Using the CLI

First access the CLI using a standard Telnet application or using a serial communication software (e.g., HyperTerminal™) connected to the MP-11x RS-232 port (refer to Section 3.1.3.1 below). Then assign the MP-11x an IP address (refer to Section 3.1.3.2 on page 16).

3.1.3.1 Access the CLI

➤ **To access the CLI via the Embedded Telnet Server, take these 3 steps:**

1. Enable the Embedded Telnet Server:
 - Access the MP-11x Embedded Web Server (refer to Section 3.3 on page 17).
 - Set the parameter 'Embedded Telnet Server' (under **Advanced Configuration > Network Settings > Application Settings**) to 'Enable (Unsecured)' or 'Enable Secured (SSL)'.
 - Click the **Reset** button on the main menu bar; the Reset screen is displayed.
 - Click the **Reset** button in the middle of the Reset screen with the Burn option selected; the MP-11x is shut down and re-activated. A message about the waiting period is displayed. The screen is refreshed.
2. Use a standard Telnet application to connect to the MP-11x Embedded Telnet Server. Note that if the Telnet server is set to SSL mode, a special Telnet client is required on your PC to connect to the Telnet interface over a secured connection.
3. Login using the username ('Admin') and password ('Admin').

➤ **To access the CLI via the RS-232 port, take these 2 steps:**

1. Connect the MP-11x RS-232 port to either COM1 or COM2 RS-232 communication port on your PC (refer to [Table 2-4](#) on page 11 for detailed information).
2. Use a serial communication software (e.g., HyperTerminal™) to connect to the MP-11x. Set your serial communication software to the following communications port settings:
 - Baud Rate: 9,600 bps
 - Data bits: 8
 - Parity: None
 - Stop bits: 1
 - Flow control: Hardware

The CLI prompt is available immediately.

3.1.3.2 Assign an IP Address

➤ **To assign an IP address via the CLI, take these 4 steps:**

1. At the prompt type 'conf' and press enter; the configuration folder is accessed.
2. To check the current network parameters, at the prompt, type 'GCP IP' and press enter; the current network settings are displayed.
3. Change the network settings by typing: 'SCP IP [ip_address] [subnet_mask] [default_gateway]' (e.g., 'SCP IP 10.13.77.7 255.255.0.0 10.13.0.1'); the new settings take effect on-the-fly. Connectivity is active at the new IP address.
Note: This command requires you to enter all three network parameters (each separated by a space).
4. To save the configuration, at the prompt, type 'SAR' and press enter; the MP-11x restarts with the new network settings.

3.2 Restoring Networking Parameters to their Initial State

You can use the 'Reset' button to restore the MP-11x networking parameters to their factory default values (described in [Table 3-1](#)) and to reset the username and password.

Note that the MP-11x returns to the software version burned in flash. This process also restores the MP-11x parameters to their factory settings. Therefore, you must load your previously backed-up *ini* file, or the default *ini* file (received with the software kit) to set them to their correct values.

➤ **To restore networking parameters to their initial state, take these 4 steps:**

1. Press in the 'Reset' button uninterruptedly for a duration of more than six seconds; the gateway is restored to its factory settings (username: 'Admin', password: 'Admin').
2. Assign the MP-11x IP address (refer to [Section 3.1](#) on page 13).
3. Load your previously backed-up *ini* file, or the default *ini* file (received with the software kit). To load the *ini* file via the Embedded Web Server, refer to the MP-11x User's Manual.
4. Press again on the 'Reset' button (this time for a short period).

3.3 Accessing the Embedded Web Server

➤ To access the Embedded Web Server, take these 4 steps:

1. Open a standard Web-browsing application such as Microsoft™ Internet Explorer™ (Version 6.0 and higher) or Netscape™ Navigator™ (Version 7.2 and higher).
2. In the URL field, specify the IP address of the MP-11x (e.g., <http://10.1.10.10>); the Embedded Web Server's 'Enter Network Password' screen appears, shown in [Figure 3-2](#).

Figure 3-2: Embedded Web Server Login Screen



3. In the 'User Name' and 'Password' fields, enter the username (default: "Admin") and password (default: "Admin"). Note that the username and password are case-sensitive.
4. Click **OK**; the 'Quick Setup' screen is accessed, shown in [Figure 3-3](#) (MGCP), [Figure 3-4](#) (H.323), and [Figure 3-5](#) (SIP).

3.4 Configuring the MP-11x *Basic Control Protocol* Parameters

To configure the MP-11x *basic* control protocol parameters use the Embedded Web Server's 'Quick Setup' screen.

- For MGCP refer to [Section 3.4.1](#) on page 17.
- For H.323, refer to [Section 3.4.2](#) on page 19.
- For SIP, refer to [Section 3.4.3](#) on page 21.

When you have completed the above relevant section you are then ready to start using the MP-11x. For information on how to fully configure the VoIP gateway, refer to the MP-11x User's Manuals.



Tip: Once the gateway is configured correctly, back up your settings by making a copy of the VoIP gateway configuration (*ini* file) and store it in a directory on your PC. This saved file can be used to restore configuration settings at a future time. For information on backing up and restoring the gateway's configuration refer to [Section 5](#) on page 25.



Note: The following configuring Sections from here up to and including [Section 3.4.3](#) on page 21 apply individually to MGCP, H.323, or SIP.
MGCP configuring continues with [Section 3.4.1](#) on page 17.
H.323 configuring continues with [Section 3.4.2](#) on page 19.
SIP configuring continues with [Section 3.4.3](#) on page 21.

3.4.1 Configuring Basic MGCP Parameters

After accessing the Embedded Web Server (refer to Section 3.3 on page 17) the MGCP 'Quick Setup' screen is displayed, shown in Figure 3-3.

Figure 3-3: MP-11x MGCP Quick Setup Screen

Quick Setup	
IP Configuration	
IP Address	10.13.77.7
Subnet Mask	255.255.0.0
Default Gateway IP Address	10.13.0.1
DNS Primary Server IP	10.1.1.10
DNS Secondary Server IP	
Enable DHCP	Disable
Control Protocol Configuration	
Control Protocol Type	MGCP
Call Agent IP	0.0.0.0
Call Agent Port	2427
Call Agent Domain Name	
Gateway Name	AudioCodes.com
Endpoint Name	ACgw
Endpoint Numbering Offset	0

➤ **To configure basic MGCP parameters, take these 10 steps:**

1. If your network features a DNS server, in the fields 'DNS Primary Server IP' and 'DNS Secondary Server IP', enter the IP address of the primary and secondary DNS servers (clarify with your network administrator). Note that the DNS server option is not supported by MGCP.
2. If your network features a DHCP server, in the 'Enable DHCP' field, select 'Enable'; the 'IP Address', 'Subnet Mask' and 'Default Gateway IP Address' fields are disabled. When the gateway is configured to use DHCP, it attempts to contact the DHCP server to obtain the networking parameters (i.e., IP address, subnet mask, default gateway and primary/secondary DNS server).
3. Select 'MGCP' in the 'Control Protocol Type' field.
4. In the 'Call Agent IP' field, enter the Call Agent IP address if your enterprise's network doesn't feature a DNS server that automatically defines the Call Agent's IP address. If you have a DNS server, the field is optional.
5. In the 'Call Agent Port' field, enter the Call Agent port. The default is 2427.
6. In the 'Call Agent Domain Name' field, enter the Call Agent domain name. When using the DNS server option, enter the domain name of the Call Agent operating with the MP-11x. The DNS server automatically detects the Call Agent's IP address from the domain name.
7. In the 'Gateway Name' field, enter a name to the device. (For example: 'gateway1.com'). Ensure that the name you choose is the one that the Call Manager/Agent is configured with to identify your MP-11x.

8. In the 'Endpoint Name' field, enter an intuitive endpoint name. Ensure that the endpoint name you choose is the one that the Call Agent works with.
9. In the 'Endpoint Numbering Offset' field, you can enter a value to offset the numbers that represent the gateway's endpoints.
10. Click the **Reset** button and click **OK** in the prompt; The MP-11x applies the changes and restarts. This takes approximately 2 minutes to complete. When the MP-11x has finished restarting, the Power and Ready LEDs on the front panel are lit green.



Note: MGCP users should continue with Section 4 Changing the MP-11x Username and Password on page 24.

3.4.2 Configuring Basic H.323 Parameters

After accessing the Embedded Web Server (refer to Section 3.3 on page 17) the H.323 'Quick Setup' screen is displayed, shown in Figure 3-4.

Figure 3-4: MP-11x H.323 Quick Setup Screen

Quick Setup	
IP Configuration	
IP Address	10.33.41.54
NAT IP Address	0.0.0.0
Subnet Mask	255.255.0.0
Default Gateway IP Address	10.33.0.1
H.323 Parameters	
Working with Gatekeeper	No
Gatekeeper IP Address	10.8.8.81
Enable Annex D/T.38 FAX Relay	No
Coder Name (msec)	
<input checked="" type="checkbox"/> 1st Coder	g729 20
Tables	
Tel to IP Routing Table	-->
Endpoint Phone Numbers	-->

➤ **To configure basic H.323 parameters, take these 7 steps:**

1. If the MP-11x is connected to a router with NAT enabled, perform the following procedure. If it isn't, leave the 'NAT IP Address' field undefined.
 - Determine the "public" IP address assigned to the router (by using, for instance, router Web management). Enter this public IP address in the 'NAT IP Address' field.
 - Enable the DMZ configuration on the residential router for the LAN port where the MP-11x gateway is connected. This enables unknown packets to be routed to the DMZ port.
2. When working with a Gatekeeper, set 'Working with Gatekeeper' field, under 'H.323 Parameters', to 'Yes' and enter the IP address of the primary Gatekeeper in the field 'Gatekeeper IP Address'. When no Gatekeeper is used, the internal routing table is used to route the calls.

3. Leave parameter 'Enable Annex D/T.38 FAX Relay' at its default unless your technical requirements differ.
4. Select the coder (i.e., vocoder) that best suits your VoIP system requirements. The default coder is: G.7231 30 msec. To program the entire list of coders you want the MP-11x to use, click the button on the left side of the '1st Coder' field; the drop-down list for the 2nd to 5th coders appear. Select coders according to your system requirements. Note that coders higher on the list are preferred and take precedence over coders lower on the list.



Note: The preferred coder is the coder that the MP-11x uses as a first choice for all connections. If the far end gateway does not use this coder, the MP-11x negotiates with the far end gateway to select a coder that both sides can use.

5. Map outgoing calls to IP addresses (*when Gatekeeper isn't used*) by completing these steps:
 - Click the arrow button next to the 'Tel to IP Routing Table' label; the 'Tel to IP Routing' screen opens.
Any telephone number whose destination number matches the prefix defined in the 'Destination Phone Prefix' field *and* whose source number matches the prefix defined in the adjacent 'Source Phone Prefix' field, is sent to the IP address entered in the 'IP Address' field.
 - Click the **Submit** button; the 'Tel to IP Routing' table is automatically updated.
 - Click **Quick Setup**; you're returned to the 'Quick Setup' screen.

For more information on the 'Tel to IP Routing' table refer to the MP-11x H.323 User's Manual.

6. Allocate MP-11x endpoints (analog lines) and their corresponding phone numbers to incoming IP calls by completing these steps:
 - Click the arrow button next to the 'Endpoint Phone Number' label; the 'Endpoint Phone Numbers' screen opens.
 - Enter the number of a channel, starting with 1, (or a group of channels), under the 'Channel(s)' column (for example 1-4 for the first 4 endpoints).
 - Assign each channel a phone number (for a group of channels, define the first number in an ordered sequence). For an example of connecting two MP-118 devices, refer to Section 3.4.4 on page 23.
 - Click the **Submit** button; the 'Endpoint Phone Number' table is automatically updated.
 - Click **Quick Setup**; you're returned to the 'Quick Setup' screen.
7. Click the **Reset** button and click **OK** in the prompt; The MP-11x applies the changes and restarts. This takes approximately 2 minutes to complete. When the MP-11x has finished restarting, the Power and Ready LEDs on the front panel are lit green.



Note: H.323 users should continue with Section 3.4.4 [Example of Connecting Two MP-118 Devices](#) on page 23.

3.4.3 Configuring Basic SIP Parameters

After accessing the Embedded Web Server (refer to Section 3.3 on page 17) the SIP 'Quick Setup' screen is displayed, shown in Figure 3-5.

Figure 3-5: MP-11x SIP Quick Setup Screen

Quick Setup	
IP Configuration	
IP Address	10.13.77.7
NAT IP Address	0.0.0.0
Subnet Mask	255.255.0.0
Default Gateway IP Address	10.13.0.1
SIP Parameters	
Gateway Name	
Working with Proxy	No
Proxy IP Address	10.13.8.10
Proxy Name	10.13.8.10
Enable Registration	No
Coder Name (msec)	
<input checked="" type="checkbox"/> 1st Coder	g711Ulaw64k 20
Tables	
Tel to IP Routing Table	-->
Endpoint Phone Number Table	-->

➤ **To configure basic SIP parameters, take these 9 steps:**

- If the MP-11x is connected to a router with NAT enabled, perform the following procedure. If it isn't, leave the 'NAT IP Address' field undefined.
 - Determine the "public" IP address assigned to the router (by using, for instance, router Web management). Enter this public IP address in the 'NAT IP Address' field.
 - Enable the DMZ configuration on the residential router for the LAN port where the MP-11x gateway is connected. This enables unknown packets to be routed to the DMZ port.
- Under 'SIP Parameters', enter the MP-11x Domain Name in the field 'Gateway Name'. If the field is not specified, the MP-11x IP address is used instead (default).
- When working with a Proxy server, set 'Working with Proxy' field to 'Yes' and enter the IP address of the primary Proxy server in the field 'Proxy IP Address'. When no Proxy is used, the internal routing table is used to route the calls.
- Enter the Proxy Name in the field 'Proxy Name'. If Proxy name is used, it replaces the Proxy IP address in all SIP messages. This means that messages are still sent to the physical Proxy IP address but the SIP URI contains the Proxy name instead.
- Configure 'Enable Registration' to 'Yes' or 'No':
 - 'No' = the MP-11x does not register to a Proxy server/Registrar (default).
 - 'Yes' = the MP-11x registers to a Proxy server/Registrar at power up and every 'Registration Time' seconds; The MP-11x sends a register request for each channel or for the entire gateway (according to the 'Authentication Mode' parameter). For detailed information on the

parameters 'Registration Time' and 'Authentication Mode', refer to the MP-11x SIP User's Manual.

6. Select the coder (i.e., vocoder) that best suits your VoIP system requirements. The default coder is: G.7231 30 msec. To program the entire list of coders you want the MP-11x to use, click the button on the left side of the '1st Coder' field; the drop-down list for the 2nd to 5th coders appears. Select coders according to your system requirements. Note that coders higher on the list are preferred and take precedence over coders lower on the list.



Note: The preferred coder is the coder that the MP-11x uses as a first choice for all connections. If the far end gateway does not use this coder, the MP-11x negotiates with the far end gateway to select a coder that both sides can use.

7. Map outgoing calls to IP addresses (*when Proxy isn't used*) by completing these steps:
 - Click the arrow button next to the 'Tel to IP Routing Table' label; the 'Tel to IP Routing' screen opens. Any telephone number whose destination number matches the prefix defined in the 'Destination Phone Prefix' field *and* whose source number matches the prefix defined in the adjacent 'Source Phone Prefix' field, is sent to the IP address entered in the 'IP Address' field.
 - Click the **Submit** button; the 'Tel to IP Routing' table is automatically updated.
 - Click **Quick Setup**; you're returned to the 'Quick Setup' screen.

For more information on the 'Tel to IP Routing' table refer to the MP-11x SIP User's Manual.

8. Allocate MP-11x endpoints (analog lines) and their corresponding phone numbers to incoming IP calls by completing these steps:
 - Click the arrow button next to the 'Endpoint Phone Number' label; the 'Endpoint Phone Numbers' screen opens.
 - Enter the number of a channel, starting with 1, (or a group of channels), under the 'Channel(s)' column (for example 1-4 for the first 4 endpoints).
 - Assign each channel a phone number (for a group of channels, define the first number in an ordered sequence) For an example of connecting two MP-118 devices, refer to Section 3.4.4 on page 23.
 - Click the **Submit** button; the 'Endpoint Phone Number' table is automatically updated.
 - Click **Quick Setup**; you're returned to the 'Quick Setup' screen.
9. Click the **Reset** button and click **OK** in the prompt; The MP-11x applies the changes and restarts. This takes approximately 2 minutes to complete. When the MP-11x has finished restarting, the Power and Ready LEDs on the front panel are lit green.



Note: SIP users should continue with Section [3.4.4 Example of Connecting Two MP-118 Devices](#) on page 23.

3.4.4 Example of Connecting Two MP-118 Devices

This example applies to H.323 and SIP. Figure 3-6 below shows an example of two MP-118/FXS devices' internal routing tables. The phone '2001' is connected to the first channel of gateway 10.2.222.108, and phone '2101' is connected to the first channel of gateway 10.2.222.107.

To make a call between two gateways, lift the receiver of phone '2001'; you hear a dial tone and the first Channel Status LED lights up. Dial 2101; after dialing the last digit phone '2101' rings.



- Note 1:** The prefixes you choose in the 'Tel to IP Routing' table *must differentiate* the gateways from each other to ensure correct routing. In the example, using the first digit (2) doesn't differentiate the devices, thus 2 digits of the phone number are used.
- Note 2:** To enable phones connected to the same MP-11x to communicate with each other, define in the internal routing table the IP address and corresponding phone numbers of the device itself (applicable only to H.323 devices).

Figure 3-6: Example of Connecting Two MP-118 Devices

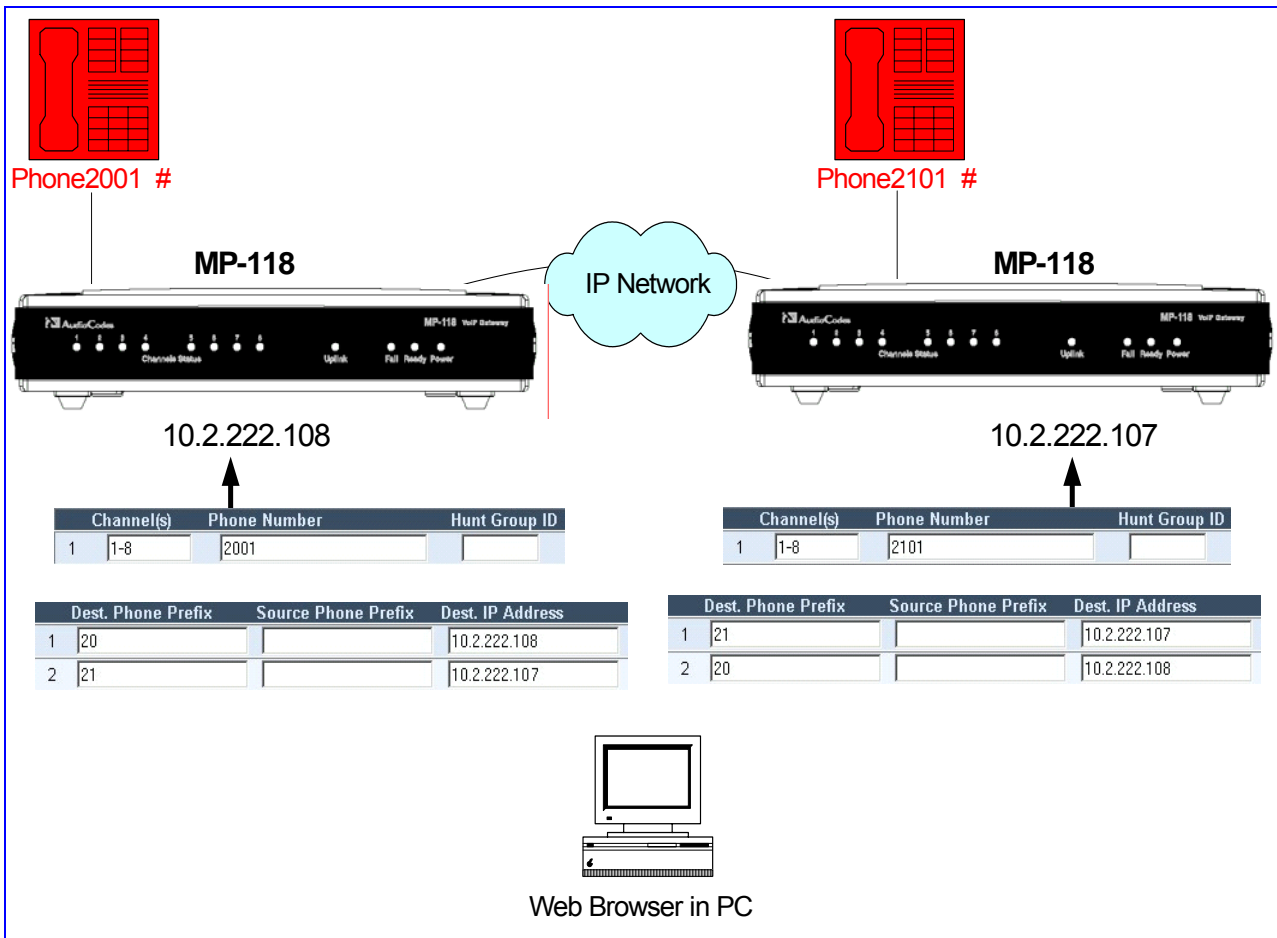



Note: The following Sections from here, up to the end of this Fast Track Guide, apply equally to MGCP, H.323 and SIP.

4 Changing the MP-11x Username and Password

To prevent unauthorized access to the Embedded Web Server, two levels of security are available: Administrator and Monitoring. Each employs a different username and password. Users can access the Embedded Web Server as either:

- Administrator - all Web screens are read-write and can be modified (default username 'Admin', default password 'Admin').
- Monitoring - all Web screens are read-only and cannot be modified. In addition, the following screens cannot be accessed: 'Reset', 'Save Configuration', 'Software Upgrade Wizard', 'Load Auxiliary Files', 'Configuration File' and 'Regional Settings'. The 'Change Password' screen can only be used to change the monitoring password (default username 'User', default password 'User').

It is recommended that you change the default username and password of the security mode you use to access the Embedded Web Server.

➤ To change the username and password, take these 5 step:

1. Access the Embedded Web Server (refer to Section 3.3 on page 17).
2. Open the 'Change Password' screen (**Advanced Configuration** menu > **Change Password**); the 'Change Password' screen is displayed.

Figure 4-1: Change Password Screen in Administrator Mode

Change Password

New User Name	<input type="text"/>
New Password	<input type="password"/>
Confirm Password	<input type="password"/>

For applying changes to the Administrator access level click the 'Change Administrator Password' button otherwise, for applying changes to the Monitoring access level click the 'Change Monitoring Password' button.

After changing the current access level password you will be prompted to re-enter the updated password.

Note: Your current access level password is the default password.
For security reasons, you are recommended to change your password.

3. In the 'User Name' and 'New Password' fields, enter the new username and the new password respectively. Note that the username and password of both levels can be a maximum of 19 case-sensitive characters.
4. In the 'Confirm Password' field, reenter the new password.
5. To apply the new username and password to the Administrator level: Click the button **Change Administrator Password**; the new username and password are applied and the 'Enter Network Password' screen appears, shown in [Figure 3-2](#). Enter the updated username and password in the 'Enter Network Password' screen. To apply the new username and password to the Monitoring level: Click the button **Change Monitoring Password**; the new username and password are applied.

5 Restoring and Backing Up the MP-11x Configuration

The 'Configuration File' screen enables you to restore (load a new *ini* file to the gateway) or to back up (make a copy of the VoIP gateway *ini* file and store it in a directory on your PC) the current configuration the gateway is using.

Back up your configuration if you want to protect your VoIP gateway programming. The backup *ini* file includes only those parameters that were modified and contain other than default values.

Restore your configuration if the VoIP gateway has been replaced or has lost its programming information, you can restore the VoIP gateway configuration from a previous backup or from a newly created *ini* file. To restore the VoIP gateway configuration from a previous backup you must have a backup of the VoIP gateway information stored on your PC.

➤ **To restore or back up the *ini* file:**

- Open the 'Configuration File' screen (**Advanced Configuration** menu > **Configuration File**); the 'Configuration File' screen is displayed.

Figure 5-1: Configuration File Screen

Configuration File

Get the *ini* file from the device to your computer

Get ini File

Send the *ini* file from your computer to the device

Browse...

Send ini File

The device will perform a 'Reset' after sending the *ini* file

➤ **To back up the *ini* file, take these 4 steps:**

1. Click the **Get ini File** button; the 'File Download' window opens.
2. Click the **Save** button; the 'Save As' window opens.
3. Navigate to the folder where you want to save the *ini* file.
4. Click the **Save** button; the VoIP gateway copies the *ini* file into the folder you selected.

➤ **To restore the *ini* file, take these 4 steps:**

1. Click the **Browse** button.
2. Navigate to the folder that contains the *ini* file you want to load.
3. Click the file and click the **Open** button; the name and path of the file appear in the field beside the **Browse** button.
4. Click the **Send ini File** button, and click **OK** in the prompt; the gateway is automatically reset (from the *cmp* version stored on the flash memory).

6 Monitoring the MP-11x

The MP-11x provides several ways of monitoring the status of the gateway:

- Monitoring the MP-11x front panel LEDs (refer to Section 6.1 below).
- Monitoring the MP-11x channels via the Embedded Web Server (refer to Section 6.2 on page 27).

6.1 Monitoring the MP-11x Front Panel LEDs

The MP-11x front panel LEDs indicate the Ethernet LAN status, Data (RTP) activity and state of the gateway ports. Table 6-1 describes the meaning of each state of the LEDs on the front panel.

Table 6-1: Definition of MP-11x Front Panel LED Indicators

LED	Type	Color	State	Definition
Ready	Device Status	Green	On	Device powered, self-test OK
			Off	Software loading or System failure
Uplink	Ethernet Link Status	Green	On	Valid 10/100 Base-TX Ethernet connection
			Off	No uplink
Power	Power Supply Status	Green	On	Power is currently being supplied to the device
			Off	Either there's a failure / disruption in the AC power supply or power is currently not being supplied to the device through the AC power supply entry.
Fail	Failure Indication	Red	On	Failure (fatal error). Or system initialization.
			Off	Normal working condition
Channels Status	Telephone Interface	Green	Blinking	The phone is ringing (incoming call, before answering).
			Fast Blinking	Line malfunction
			Off	Normal onhook position
			On	Offhook

6.2 Monitoring the MP-11x Channels

➤ To monitor the status of the channels:

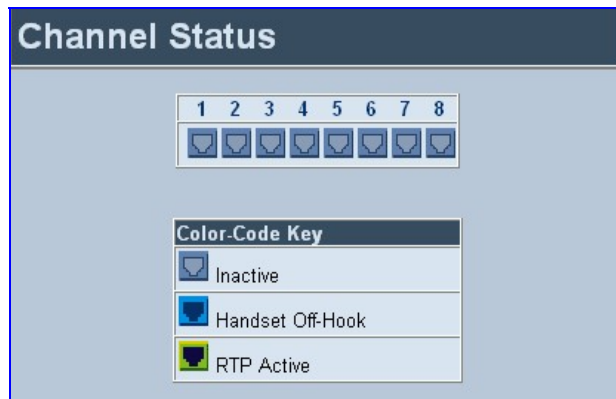

- Open the Channel Status screen (**Status & Diagnostics** menu > **Channel Status**); the Channel Status screen is displayed.

Figure 6-1: MP-11x Channel Status Screen



The color of each channel shows the call status of that channel. Refer to [Table 6-2](#) below for information on the different statuses a call can have.

Table 6-2: Channel Status Color Indicators

Indicator	Label	Description
	Inactive	Indicates this channel is currently onhook
	RTP Active	Indicates an active RTP stream.
	Handset Offhook	Indicates this channel is offhook but there is no active RTP session.

➤ To monitor the details of a channel, take these 2 steps:

1. In the Channel Status screen, click the numbered icon of the specific channel whose detailed status you need to check/monitor; the channel-specific **Channel Status** screen appears.
2. Click the submenu links to check/view a specific channel's parameter settings.

7 Upgrading the MP-11x

To upgrade the MP-11x (load new software or auxiliary files onto the VoIP gateway) use the Software Update feature, available through the Embedded Web Server.

The 'Software Update' menu comprises two submenus:

- Software Update Wizard (refer to Section 7.1 below).
- Auxiliary Files (refer to Section 7.2 on page 33).



Note: When you upgrade the MP-11x software you *must* load the new *cmp* file with all other related configuration files: coefficient, Call Progress Tones, Voice Prompts and Prerecorded Tones.

7.1 Software Upgrade Wizard

The Software Upgrade Wizard guides users through the process of software upgrade: selecting files and loading them to the gateway. The wizard also enables users to upgrade software while maintaining the existing configuration. Using the wizard obligates users to load a *cmp* file. Users can choose to also use the Wizard to load auxiliary files (*ini*, Call Progress Tones, Voice Prompts and FXS coefficient files) but this option cannot be pursued without loading the *cmp* file. For each auxiliary file type, users can choose to reload an existing file, load a new file or not load a file at all.



Note: The Software Upgrade Wizard requires the device to be reset at the end of the process. This disrupts any traffic existing on the device. To avoid disruption, disable all traffic on the device before initiating the Wizard.

➤ **To use the Software Upgrade Wizard, take these 9 steps:**

1. Stop all traffic on the device (refer to the note above).
2. Open the 'Software Upgrade Wizard' (**Software Update** menu > **Software Upgrade Wizard**); the 'Start Software Upgrade' screen appears.

Figure 7-1: Start Software Upgrade Screen

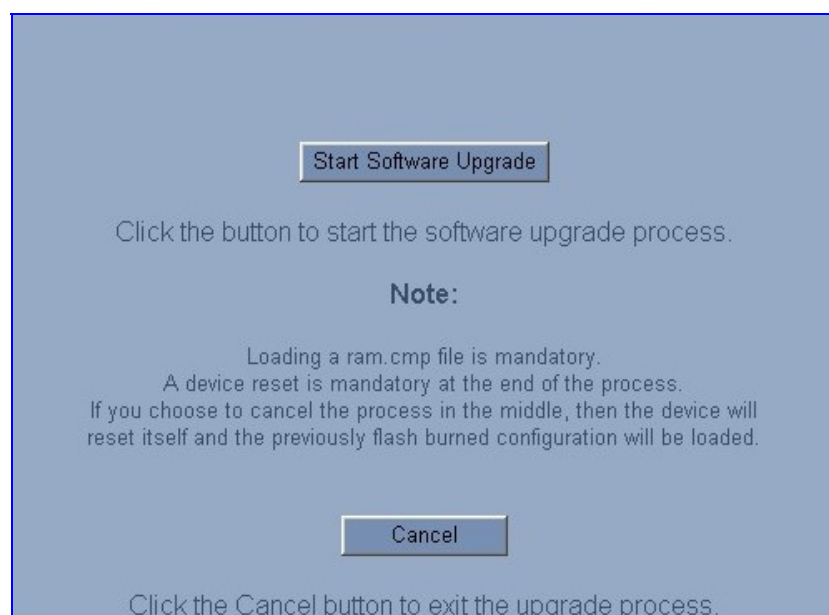



Note: At this point, the process can be canceled with no consequence to the device (click the **Cancel** button). If you continue the process (by clicking the **Start Software Upgrade** button, the process must be followed through and completed with a device reset at the end. If you click the **Cancel** button in any of the subsequent screens, the device is automatically reset with the configuration that was previously burned in flash memory.

- Click the **Start Software Upgrade** button; the 'Load a cmp file' screen appears (Figure 7-2).



Note: When in the Wizard process, the rest of the Web application is unavailable and the background Web screen is disabled. After the process is completed, access to the full Web application is restored.

Figure 7-2: Load a *cmp* File Screen

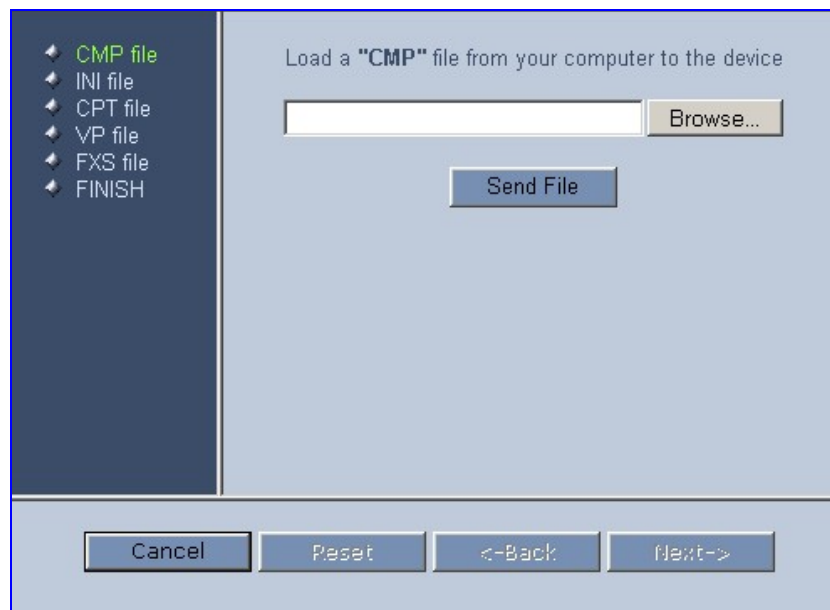

- Click the **Browse** button, navigate to the *cmp* file and click the button **Send File**; the *cmp* file is loaded to the device and you're notified as to a successful loading (refer to Figure 7-3).

Figure 7-3: *cmp* File Successfully Loaded into the Device Notification

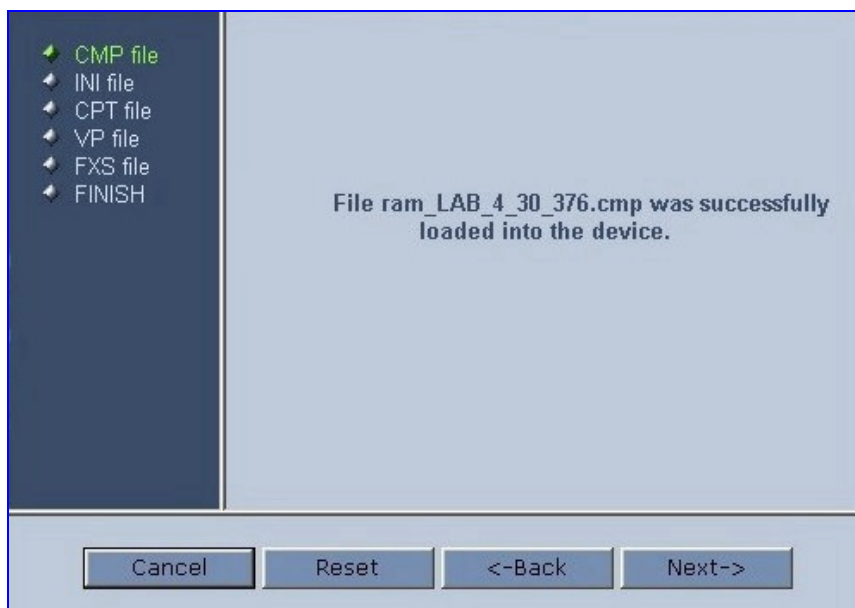

5. Note that the four action buttons (**Cancel**, **Reset**, **Back**, and **Next**) are now activated (following *cmp* file loading).

You can now choose to either:

- Click **Reset**; the device resets, utilizing the new *cmp* you loaded and utilizing the current configuration files.
- Click **Cancel**; the device resets utilizing the *cmp*, *ini* and all other configuration files that were previously stored in flash memory. Note that these are NOT the files you loaded in the previous Wizard steps.
- Click **Back**; the 'Load a *cmp* File' screen is reverted to; refer to [Figure 7-2](#).
- Click **Next**; the 'Load an *ini* File' screen opens; refer to [Figure 7-4](#). Loading a new *ini* file or any other auxiliary file listed in the Wizard is optional.

Note that as you progress, the file type list on the left indicates which file type loading is in process by illuminating green (until 'FINISH').

Figure 7-4: Load an *ini* File Screen

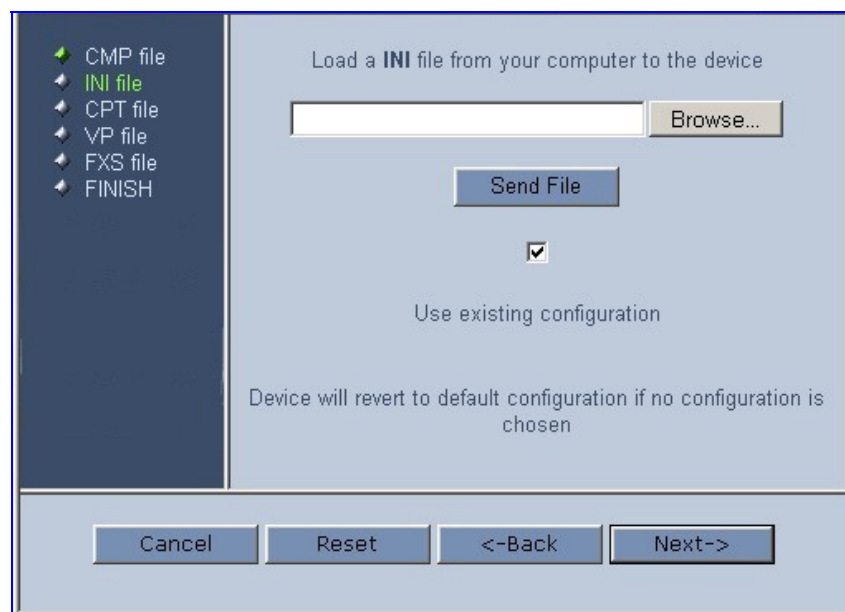

6. In the 'Load an *ini* File' screen, you can now choose to either:

- Click **Browse** and navigate to the *ini* file; the check box 'Use existing configuration', by default checked, becomes unchecked. Click **Send File**; the *ini* file is loaded to the device and you're notified as to a successful loading.
- Ignore the **Browse** button (its field remains undefined and the check box 'Use existing configuration' remains checked by default).
- Ignore the **Browse** button and uncheck the 'Use existing configuration' check box; no *ini* file is loaded, the device uses its factory-preconfigured values.

You can now choose to either:

- Click **Cancel**; the device resets utilizing the *cmp*, *ini* and all other configuration files that were previously stored in flash memory. Note that these are NOT the files you loaded in the previous Wizard steps.
- Click **Reset**; the device resets, utilizing the new *cmp* and *ini* file you loaded up to now as well as utilizing the other configuration files.
- Click **Back**; the 'Load a *cmp* file' screen is reverted to; refer to [Figure 7-2](#).
- Click **Next**; the 'Load a CPT File' screen opens, refer to [Figure 7-5](#); Loading a new CPT file or any other auxiliary file listed in the Wizard is optional.

Figure 7-5: Load a CPT File Screen

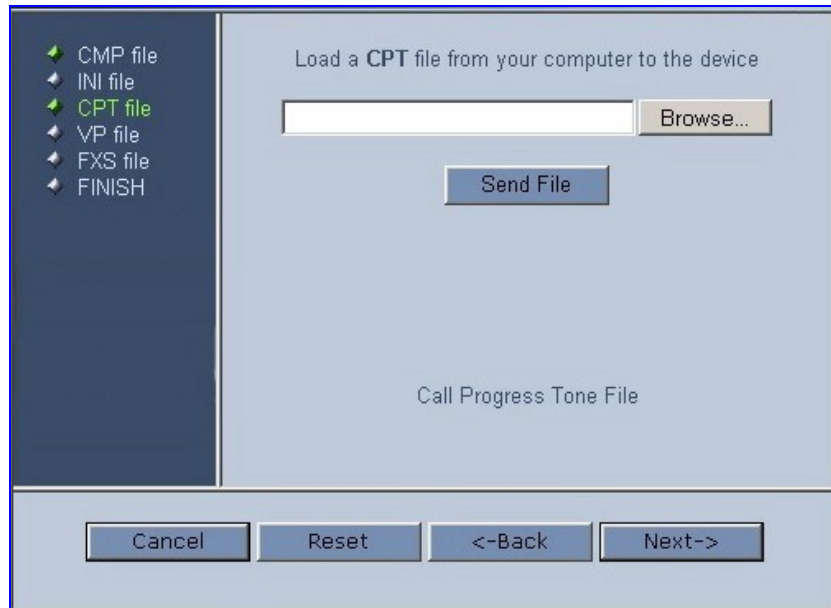

7. Follow the same procedure you followed when loading the *ini* file (refer to Step 6). The same procedure applies to the 'Load a VP file' (not applicable to the MP-11x gateway) screen and 'Load a coefficient file' screen.
8. In the 'FINISH' screen (refer to Figure 7-6), the **Next** button is disabled. Complete the upgrade process by clicking **Reset** or **Cancel**.

Button	Result
Reset	The device 'burns' the newly loaded files to flash memory. The 'Burning files to flash memory' screen appears. Wait for the 'burn' to finish. When it finishes, the 'End Process' screen appears displaying the burned configuration files (refer to Figure 7-7).
Cancel	The device resets, utilizing the files previously stored in flash memory. (Note that these are NOT the files you loaded in the previous Wizard steps).

Figure 7-6: FINISH Screen

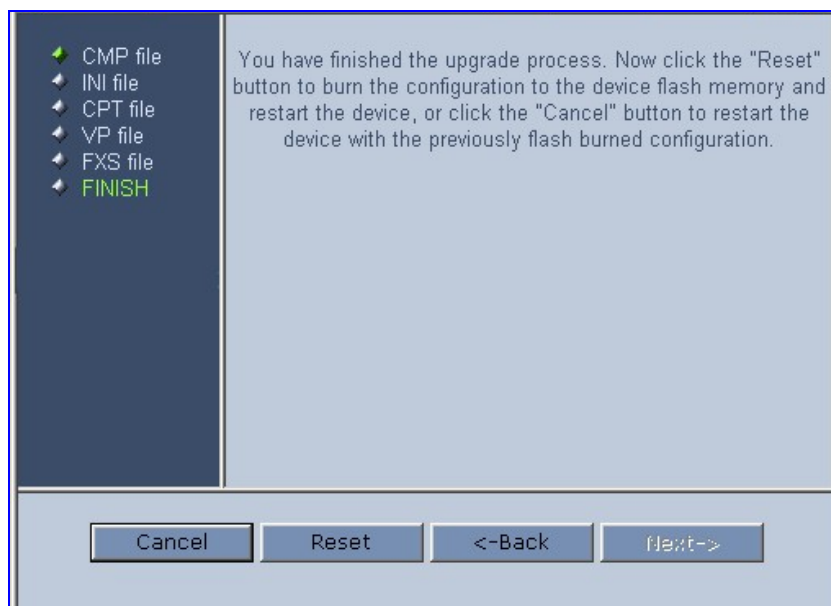
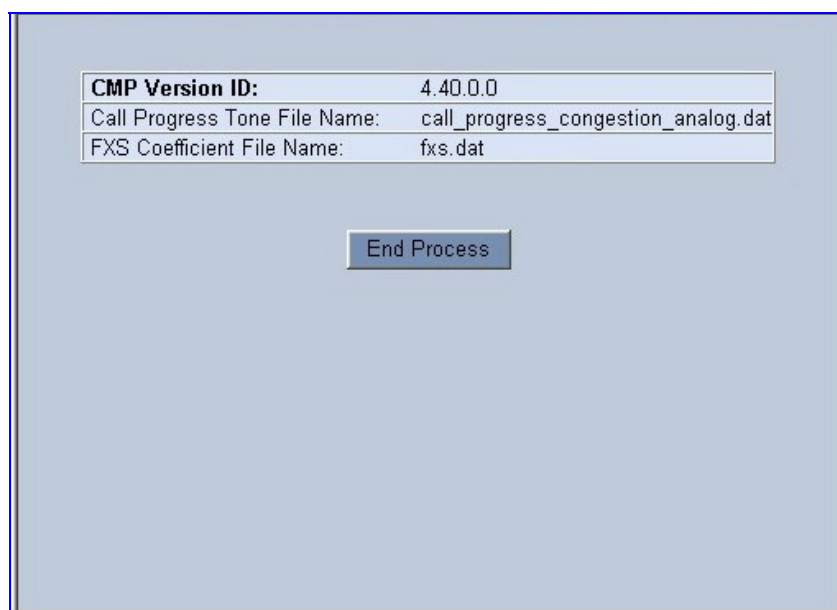

Figure 7-7: 'End Process' Screen



9. Click the **End Process** button; the 'Quick Setup' screen appears and the full Web application is reactivated.

7.2 Updating the Auxiliary Files

The auxiliary files are configuration *dat* files that are loaded to the gateway (in addition to the *ini* file) to enable enhanced gateway provisioning. The following auxiliary files are available: coefficient, Voice Prompts, Call Progress Tones (CPT) and Prerecorded Tones (PRT). The PRT and Voice Prompts files are currently applicable only to MGCP. Table 7-1 presents a brief description of the *ini* file and of each auxiliary file.

Table 7-1: *ini* and Auxiliary Files Descriptions

File Type	Description
<i>Ini</i>	Load this file to provision the device's parameters. The Embedded Web Server enables practically full device provisioning but customers may occasionally require new feature configuration parameters in which case this file is loaded. Note that loading the <i>ini</i> file only provisions parameters that are contained in the <i>ini</i> file. If a parameter is not specified in the <i>ini</i> file, values associated with that parameter are reset to a default value. These values may not be the same as the values that were configured for the VoIP gateway at the time of manufacture. Note: After the file has completed loading, the VoIP gateway automatically restarts (software is loaded from the flash).
Coefficient	This file contains the telephony interface configuration information for the VoIP gateway. This information includes telephony interface characteristics, such as DC and AC impedance, feeding current and ringing voltage. This file is specific to the type of telephony interface that the VoIP gateway supports. In most cases you have to load this type of file.
Voice Prompts	The voice announcement file contains a set of Voice Prompts to be played by the MP-11x during operation on Call Agent request. Only MGCP is supported.
Call Progress Tones	This is a region-specific, telephone exchange-dependent file that contains the Call Progress Tones levels and frequencies that the VoIP gateway uses. Default CPT file: U.S.A.
Prerecorded Tones	The <i>dat</i> PRT file enhances the device's capabilities to play a wide range of telephone exchange tones. Only MGCP is supported.

➤ **To load an auxiliary file via the Embedded Web Server, take these 6 steps:**

1. Open the 'Auxiliary Files' screen (**Software Update** menu > **Load Auxiliary Files**); the 'Auxiliary Files' screen is displayed (shown in Figure 7-8).
2. Click the **Browse** button that is in the field for the type of file you want to load.
3. Navigate to the folder that contains the file you want to load.
4. Click the file and click the **Open** button; the name and path of the file appear in the field next to the **Browse** button.
5. Click the **Send File** button adjacent to the field that contains the name of the file you want to load. An asterisk in the screen section indicates that the file's loading takes effect on-the-fly (e.g., Voice Prompts file).
6. Repeat steps 2 to 5 for each file you want to load.

Figure 7-8: Auxiliary Files Screen

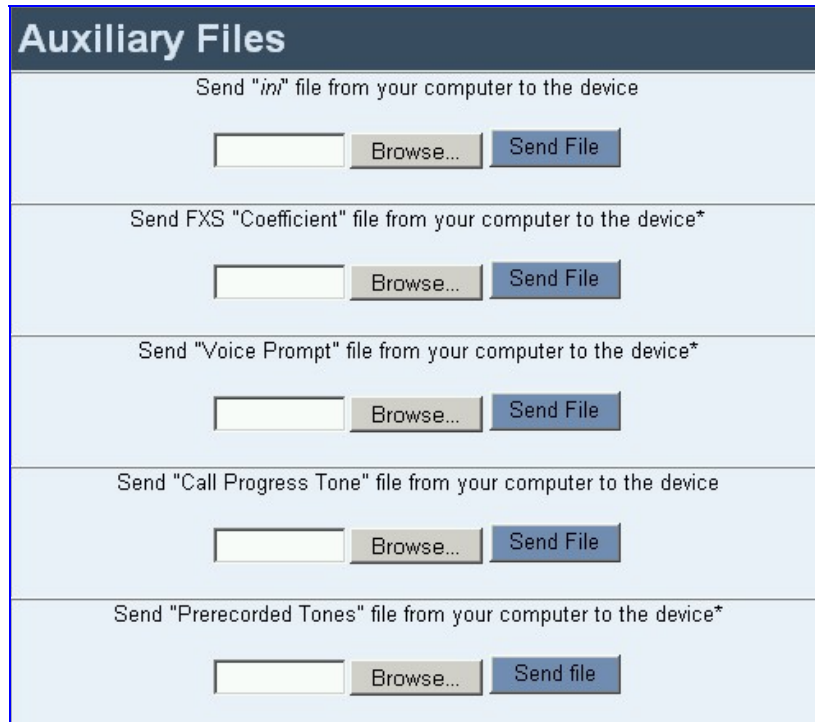

➤ **To save the loaded auxiliary files to flash memory, take these 2 steps:**

1. Click the **Save Configuration** button on the main menu bar; the 'Save Configuration to the Flash Memory' screen is displayed.



Note: Saving an auxiliary file to flash memory may disrupt traffic on the device. To avoid this, disable all traffic on the device before saving to flash memory.

2. Click the **Save Configuration** button in the middle of the screen; a confirmation message appears when the save is complete.



Note: A device reset is required to activate a loaded CPT file, and may be required for the activation of certain *ini* file parameters.

➤ **To reset the MP-11x, take these 2 steps:**

1. Click the **Reset** button on the main menu bar; the 'Reset' screen is displayed.
2. Click the **Reset** button in the middle of the screen; the auxiliary files are saved into flash and the MP-11x restarts. This takes approximately 2 minutes to complete. When the MP-11x has finished restarting, the Power and Ready LEDs on the front panel are lit green.

8 Regulatory Information

<i>Declaration of Conformity</i>	
Application of Council Directives:	73/23/EEC (including amendments), 89/336/EEC (including amendments),
Standards to which Conformity is Declared:	EN55022: 1998, Class B EN55024:1998 EN61000-3-2: 1995 (including amendments A1: 1998, A2: 1998, A14: 2000) EN61000-3-3: 1995 EN60950-1: 2001
Manufacturer's Name:	AudioCodes Ltd.
Manufacturer's Address:	1 Hayarden Street, Airport City, Lod 70151, Israel.
Type of Equipment:	Analog VoIP System.
Model Numbers:	MP-11x/FXS (x- may represent 2, 4, 8)
I, the undersigned, hereby declare that the equipment specified above conforms to the above Directives and Standards.	
	11 th February 2005 Airport City, Lod, Israel
<i>Signature</i> I. Zusmanovich, Compliance Engineering Manager	<i>Date (Day/Month/Year)</i> <i>Location</i>

Czech	[AudioCodes Ltd] tímto prohlašuje, že tento [MP-11x/FXS series] je ve shodě se základními požadavky a dalšími příslušnými ustanoveními směrnice 89/336/EEC, 73/23/EEC.
Danish	Undertegnede [AudioCodes Ltd] erklærer herved, at følgende udstyr [MP-11x/FXS Series] overholder de væsentlige krav og øvrige relevante krav i direktiv 89/336/EEC, 73/23/EEC.
Dutch	Hierbij verklaart [AudioCodes Ltd] dat het toestel [MP-11x/FXS Series] in overeenstemming is met de essentiële eisen en de andere relevante bepalingen van richtlijn 89/336/EEC, 73/23/EEC
English	Hereby, [AudioCodes Ltd], declares that this [MP-11x/FXS Series] is in compliance with the essential requirements and other relevant provisions of Directive 89/336/EEC, 73/23/EEC.
Estonian	Käesolevaga kinnitab [AudioCodes Ltd] seadme [MP-11x/FXS Series] vastavust direktiivi 89/336/EEC, 73/23/EEC põhinõuetele ja nimetatud direktiivist tulenevatele teistele asjakohastele sätetele.
Finnish	[AudioCodes Ltd] vakuuttaa täten että [MP-11x/FXS Series] tyypinen laite on direktiivin 89/336/EEC, 73/23/EEC oleellisten vaatimusten ja sitä koskevien direktiivin muiden ehtojen mukainen.
French	Par la présente [AudioCodes Ltd] déclare que l'appareil [MP-11x/FXS Series] est conforme aux exigences essentielles et aux autres dispositions pertinentes de la directive 89/336/EEC, 73/23/EEC
German	Hiermit erkläre [AudioCodes Ltd], dass sich dieser/diese/dieses [MP-11x/FXS Series] in Übereinstimmung mit den grundlegenden Anforderungen und den anderen relevanten Vorschriften der Richtlinie 89/336/EEC, 73/23/EEC befindet". (BMW)
Greek	ΜΕ ΤΗΝ ΠΑΡΟΥΣΑ [AudioCodes Ltd] ΔΗΛΩΝΕΙ ΟΤΙ [MP-11x/FXS Series] ΣΥΜΜΟΡΦΩΝΕΤΑΙ ΠΡΟΣ ΤΙΣ ΟΥΣΙΩΔΕΙΣ ΑΠΑΙΤΗΣΕΙΣ ΚΑΙ ΤΙΣ ΛΟΙΠΕΣ ΣΧΕΤΙΚΕΣ ΔΙΑΤΑΞΕΙΣ ΤΗΣ ΟΔΗΓΙΑΣ 89/336/EEC, 73/23/EEC
Hungarian	Alulírott, [AudioCodes Ltd] nyilatkozom, hogy a [MP-11x/FXS Series] megfelel a vonatkozó alapvető követelményeknek és az 89/336/EEC, 73/23/EEC irányelv egyéb előírásainak
Icelandic	æki þetta er í samræmi við tilskipun Evrópusambandsins 89/336/EEC, 73/23/EEC
Italian	Con la presente [AudioCodes Ltd] dichiara che questo (MP-11x/FXS Series) è conforme ai requisiti essenziali ed alle altre disposizioni pertinenti stabilite dalla direttiva 89/336/EEC, 73/23/EEC.
Latvian	Ar šo [AudioCodes Ltd] deklarē, ka [MP-11x/FXS Series] atbilst Direktīvas 89/336/EEC, 73/23/EEC būtiskajām prasībām un citiem ar to saistītajiem noteikumiem.
Lithuanian	[AudioCodes Ltd] deklaruoja, kad irenginys [MP-11x/FXS Series] tenkina 89/336/EEC, 73/23/EEC Direktyvos esminius reikalavimus ir kitas sios direktyvos nuostatas
Maltese	Hawnhekk, [AudioCodes Ltd], jiddikjara li dan [MP-11x/FXS Series] jikkonforma mal-htigijiet essenzjali u ma provvedimenti oħrajn relevanti li hemm fid-Dirrettiva 89/336/EEC, 73/23/EEC
Norwegian	Dette produktet er i samhörighet med det Europeiske Direktiv 89/336/EEC, 73/23/EEC
Polish	[AudioCodes Ltd], deklarujemy z pełną odpowiedzialnością, że wyrób [MP-11x/FXS Series] spełnia podstawowe wymagania i odpowiada warunkom zawartym w dyrektywie 89/336/EEC, 73/23/EEC
Portuguese	[AudioCodes Ltd] declara que este [MP-11x/FXS Series] está conforme com os requisitos essenciais e outras disposições da Directiva 89/336/EEC, 73/23/EEC.
Slovak	[AudioCodes Ltd] týmto vyhlasuje, že [MP-11x/FXS Series] spĺňa základné požiadavky a všetky príslušné ustanovenia Smernice 89/336/EEC, 73/23/EEC.
Slovene	Šiuo [AudioCodes Ltd] deklaruojta, kad šis [MP-11x/FXS Series] atitinka esminius reikalavimus ir kitas 89/336/EEC, 73/23/EEC Direktyvos nuostatas.
Spanish	Por medio de la presente [AudioCodes Ltd] declara que el (MP-11x/FXS Series) cumple con los requisitos esenciales y cualesquiera otras disposiciones aplicables o exigibles de la Directiva 89/336/EEC, 73/23/EEC
Swedish	Härmed intygar [AudioCodes Ltd] att denna [MP-11x/FXS Series] står i överensstämmelse med de väsentliga egenskapskrav och övriga relevanta bestämmelser som framgår av direktiv 89/336/EEC, 73/23/EEC.

Safety Notice

Installation and service of this unit must only be performed by authorized, qualified service personnel.

The protective earth terminal on the back of the MP-11x/FXS must be permanently connected to protective earth.

Telecommunication Safety

The safety status of each port on the gateway is declared and detailed in the table below:

Ports	Safety Status
Ethernet (100 Base-TX)	SELV
FXS (ODP P/N's) FXS	TNV-3 TNV-2

TNV-3: Circuit whose normal operating voltages exceeds the limits for an SELV circuit under normal operating conditions and on which over voltages from Telecommunication Networks are possible
 SELV: Safety extra low voltage circuit.

FCC Statement

This equipment has been tested and found to comply with the limits for a Class B digital device, pursuant to part 15 of the FCC Rules. These limits are designed to provide reasonable protection against harmful interference in a residential installation. This equipment generates uses and can and can radiate radio frequency energy and, if not installed and used in accordance with the instructions, may cause harmful interference to radio communications. However there is no guarantee that interference will not occur in a particular installation. If this equipment does cause harmful interference to radio or television reception, which can be determined by turning the equipment off and on, the user is encouraged to try to correct the interference by one or more of the following measures:

- Reorient or relocate the receiving antenna.
- Increase the separation between the equipment and receiver.
- Connect the equipment into an outlet on a circuit different from that to which the receiver is connected.
- Consult the dealer or an experienced radio/TV technician for help.



MediaPack™ Analog VoIP Gateways
Series